

tema 1

Determinare le reazioni vincolari e diagrammi N, T, M

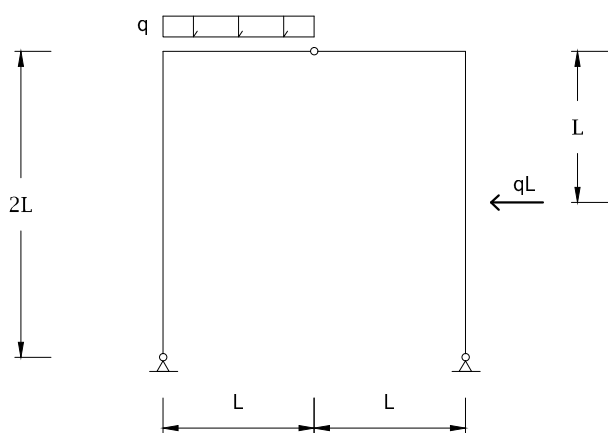

tema 10

Determinare le reazioni vincolari e diagrammi N, T, M

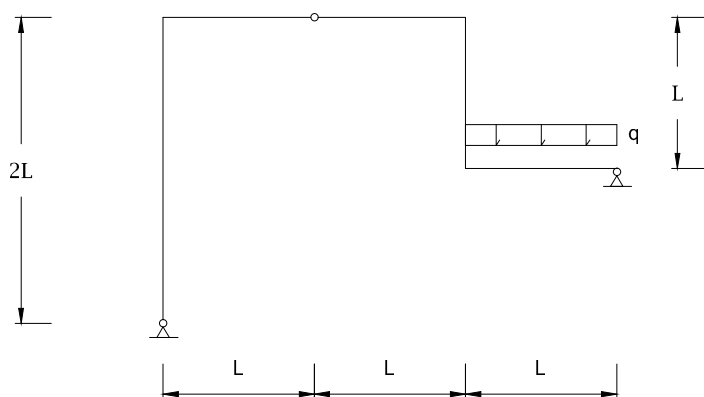

tema 11

Determinare le reazioni vincolari e diagrammi N, T, M

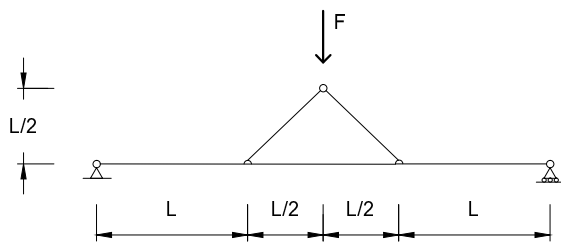

tema 12

Determinare le reazioni vincolari e diagrammi N, T, M

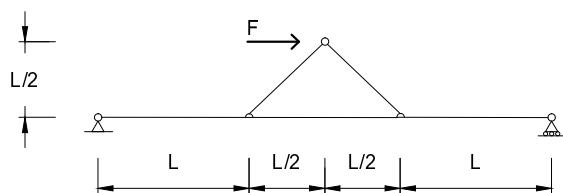

tema 13

Determinare le reazioni vincolari e diagrammi N, T, M

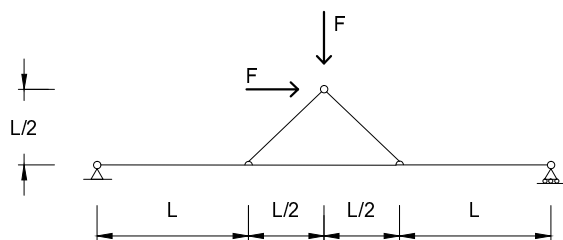

tema 14

Determinare le reazioni vincolari e diagrammi N, T, M

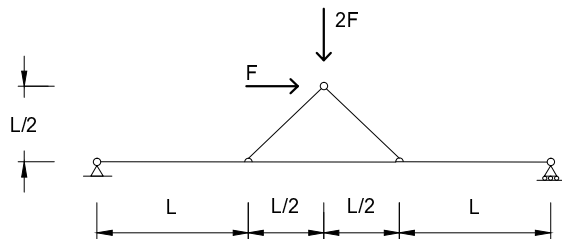

tema 15

Determinare le reazioni vincolari e diagrammi N, T, M

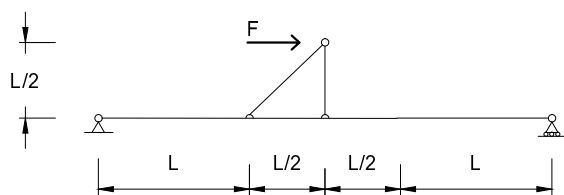

tema 16

Determinare le reazioni vincolari e diagrammi N, T, M

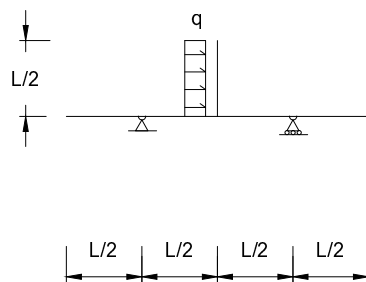

tema 17

Determinare le reazioni vincolari e diagrammi N, T, M

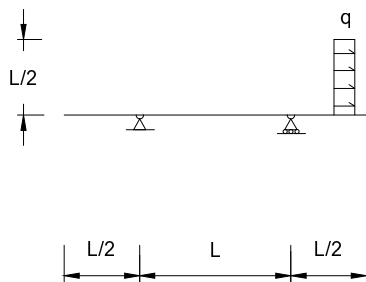

tema 18

Determinare le reazioni vincolari e diagrammi N, T, M

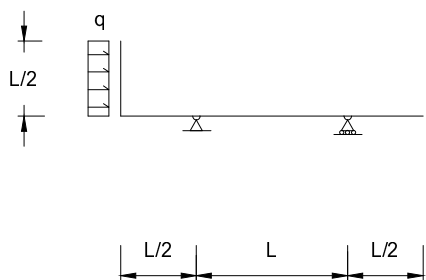

tema 19

Determinare le reazioni vincolari e diagrammi N, T, M

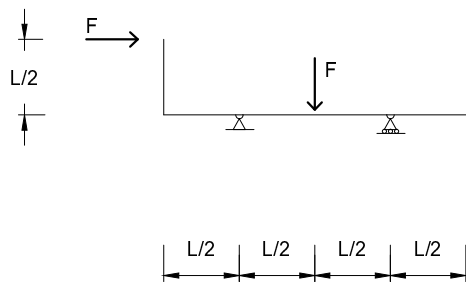

tema 2

Determinare le reazioni vincolari e diagrammi N, T, M

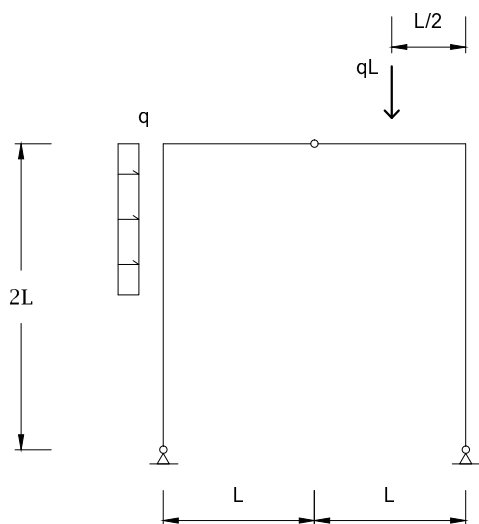

tema 20

Determinare le reazioni vincolari e diagrammi N, T, M

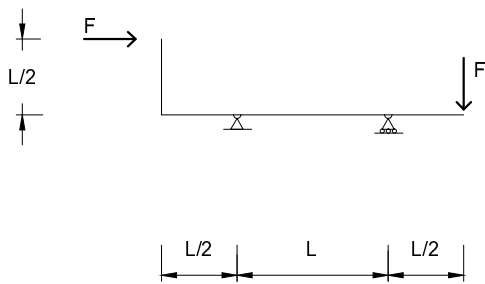

tema 21

Determinare le reazioni vincolari e diagrammi N, T, M

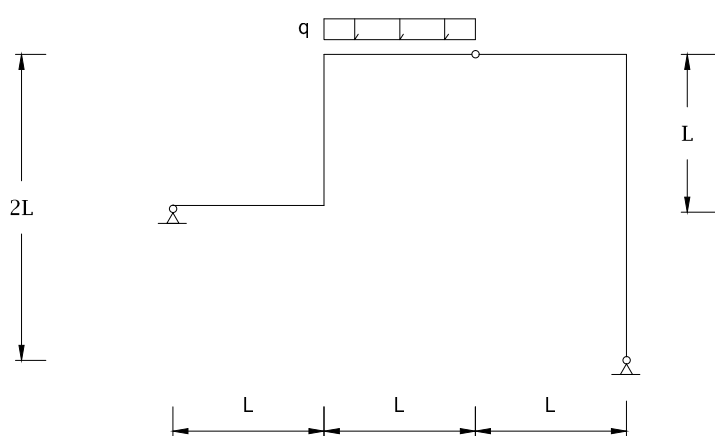

tema 22

Determinare le reazioni vincolari e diagrammi N, T, M

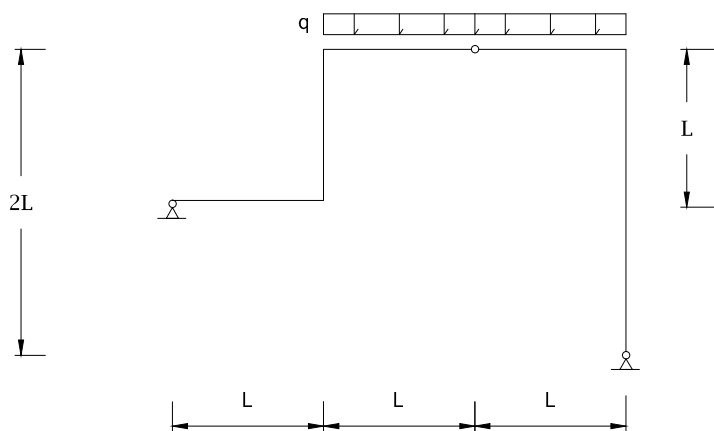

tema 24

Determinare le reazioni vincolari e diagrammi N, T, M

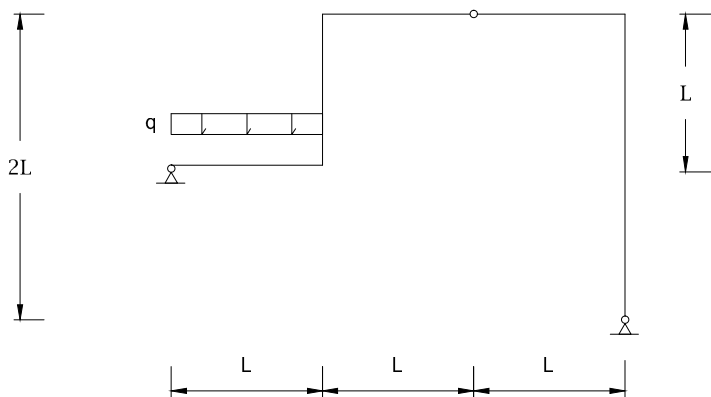

tema 25

Determinare le reazioni vincolari e diagrammi N, T, M

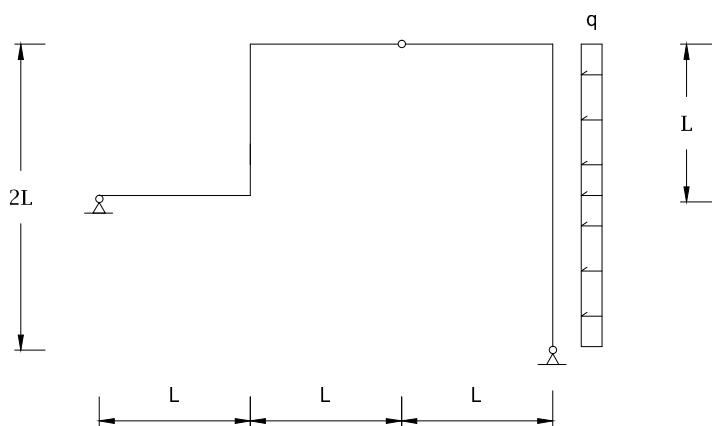

tema 26

Determinare le reazioni vincolari e diagrammi N, T, M

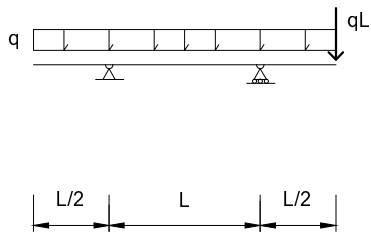

tema 27

Determinare le reazioni vincolari e diagrammi N, T, M

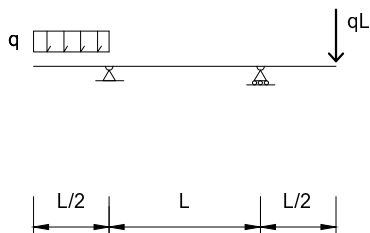

tema 28

Determinare le reazioni vincolari e diagrammi N, T, M

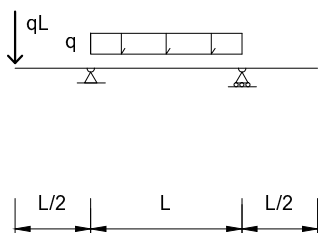

tema 29

Determinare le reazioni vincolari e diagrammi N, T, M

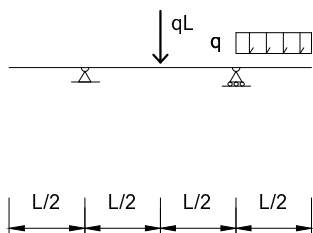

tema 3

Determinare le reazioni vincolari e diagrammi N, T, M

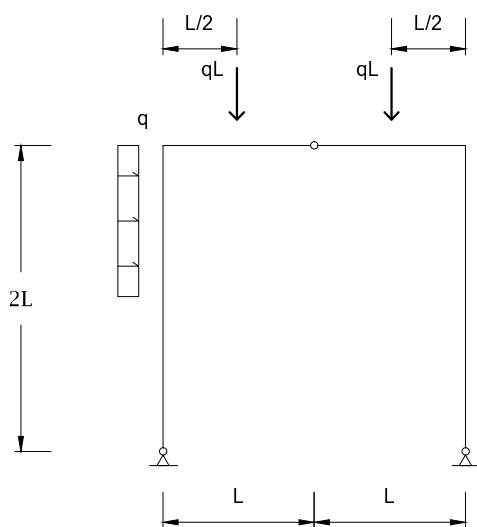

tema 30

Determinare le reazioni vincolari e diagrammi N, T, M

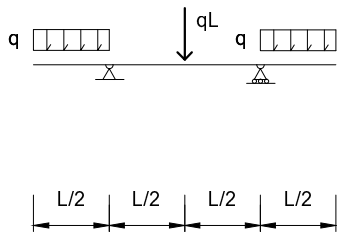

tema 4

Determinare le reazioni vincolari e diagrammi N, T, M

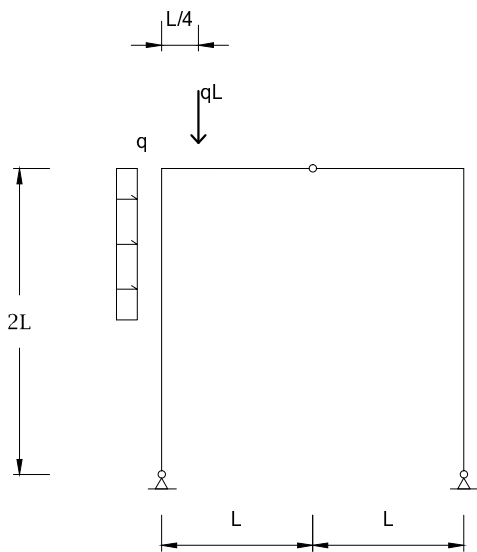

tema 5

Determinare le reazioni vincolari e diagrammi N, T, M

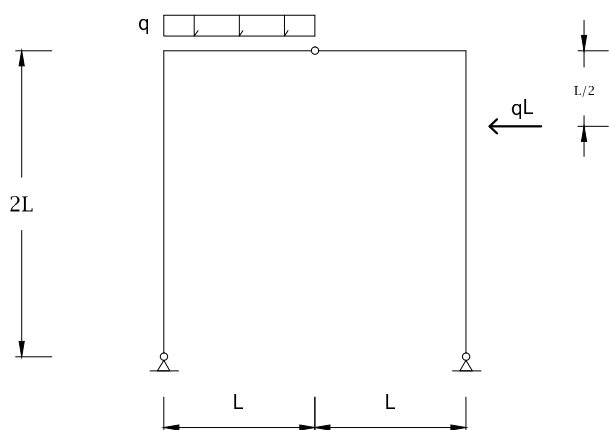

tema 6

Determinare le reazioni vincolari e diagrammi N, T, M

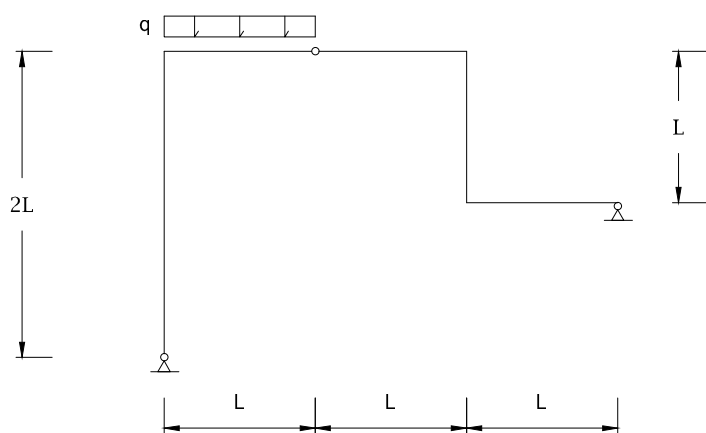

tema 7

Determinare le reazioni vincolari e diagrammi N, T, M

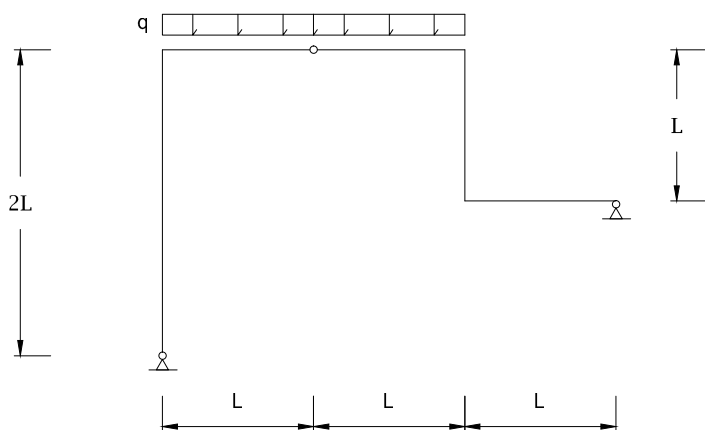

tema 8

Determinare le reazioni vincolari e diagrammi N, T, M

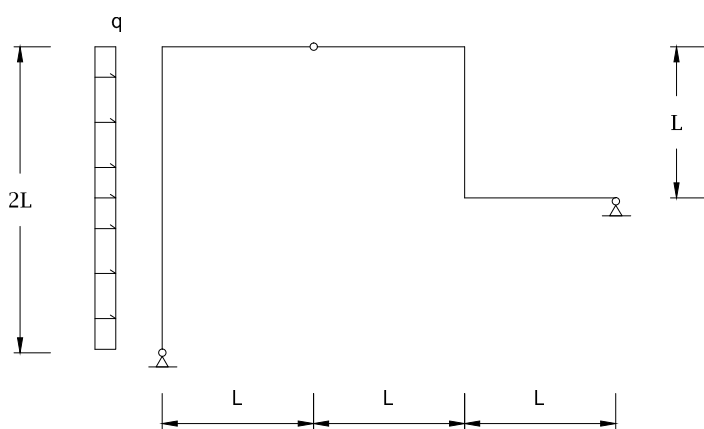

tema 9

Determinare le reazioni vincolari e diagrammi N, T, M

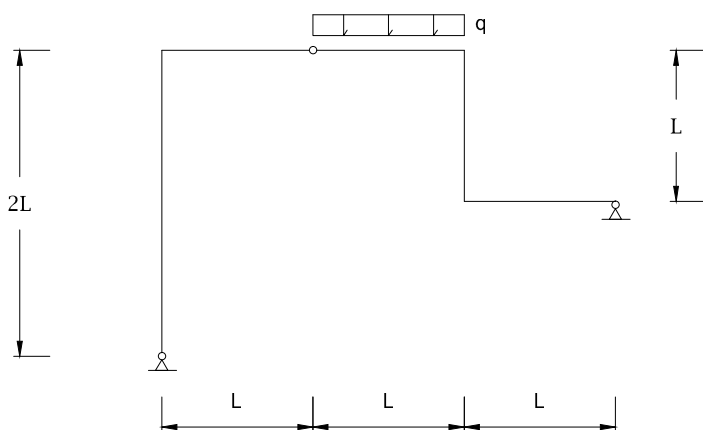

tema 23

Determinare le reazioni vincolari e diagrammi N, T, M

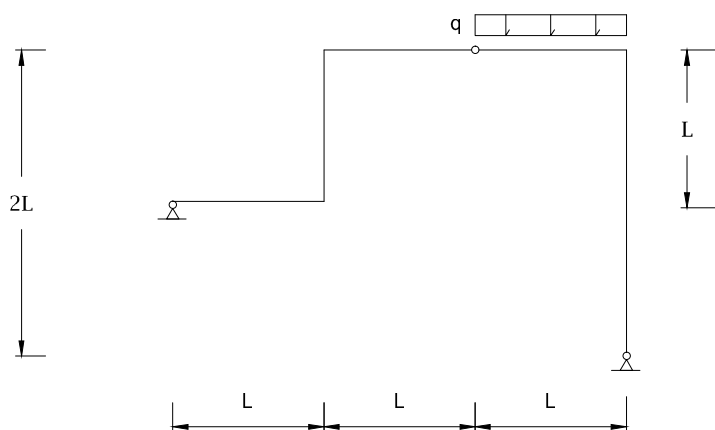

tema 31

Determinare le reazioni vincolari e diagrammi N, T, M

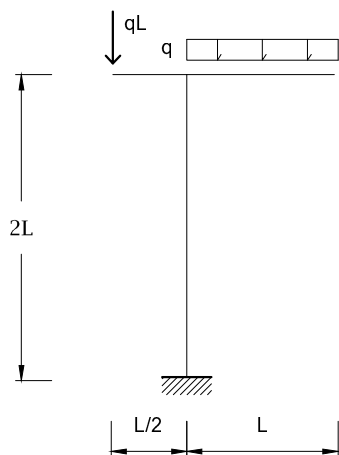

tema 32

Determinare le reazioni vincolari e diagrammi N, T, M

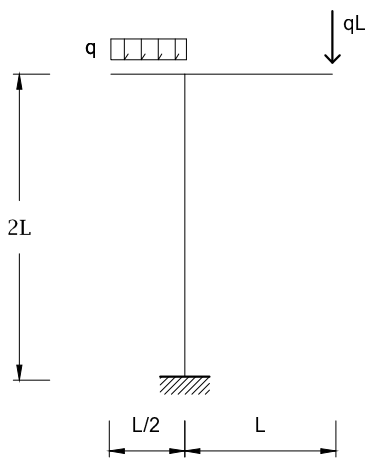

tema 33

Determinare le reazioni vincolari e diagrammi N, T, M

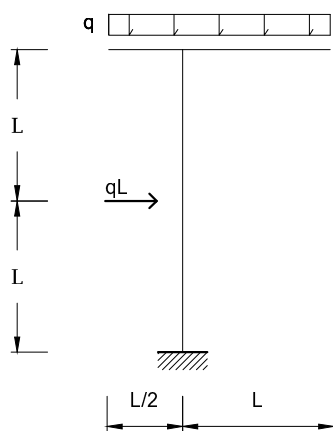

tema 34

Determinare le reazioni vincolari e diagrammi N, T, M

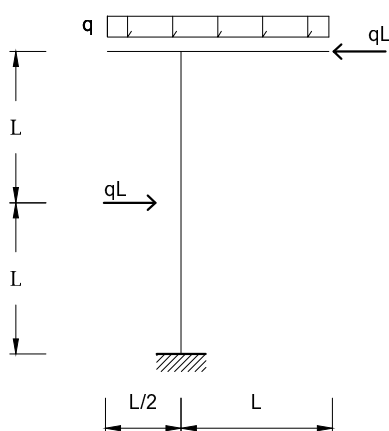

tema 35

Determinare le reazioni vincolari e diagrammi N, T, M

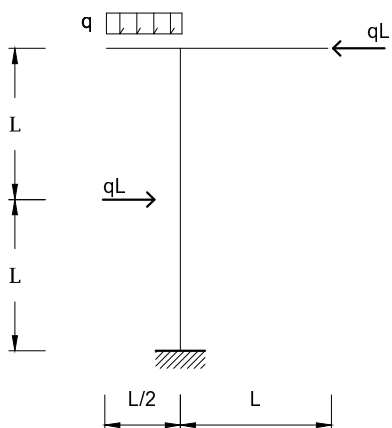

tema 36

Determinare le reazioni vincolari e diagrammi N, T, M

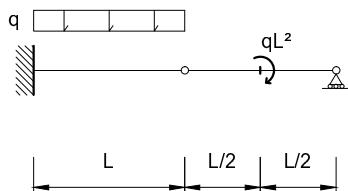

tema 37

Determinare le reazioni vincolari e diagrammi N, T, M

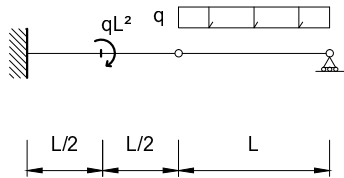

tema 38

Determinare le reazioni vincolari e diagrammi N, T, M

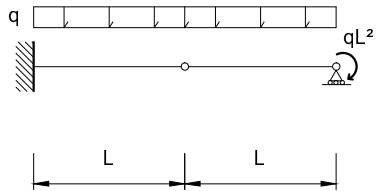

tema 39

Determinare le reazioni vincolari e diagrammi N, T, M

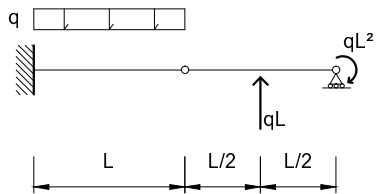

tema 41

Determinare le reazioni vincolari e diagrammi N, T, M

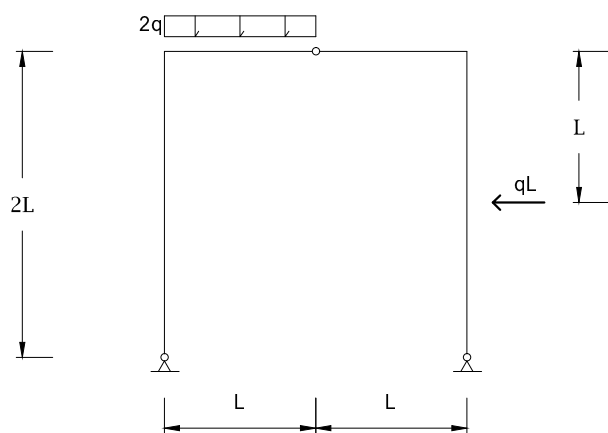

tema 42

Determinare le reazioni vincolari e diagrammi N, T, M

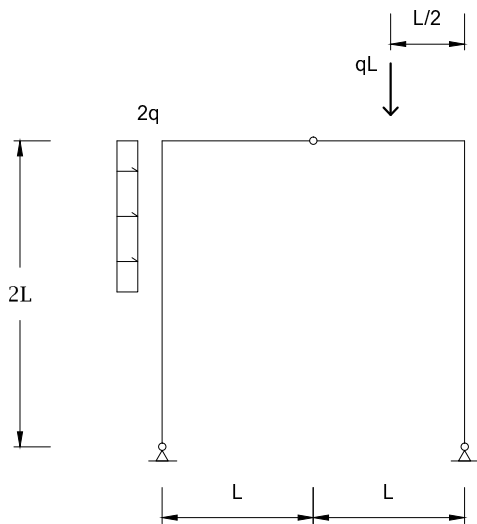

tema 43

Determinare le reazioni vincolari e diagrammi N, T, M

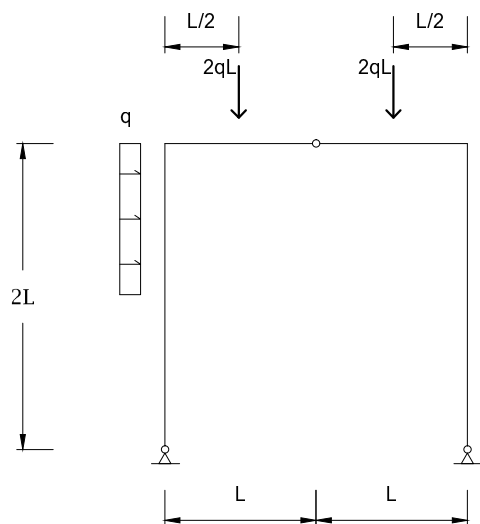

tema 44

Determinare le reazioni vincolari e diagrammi N, T, M

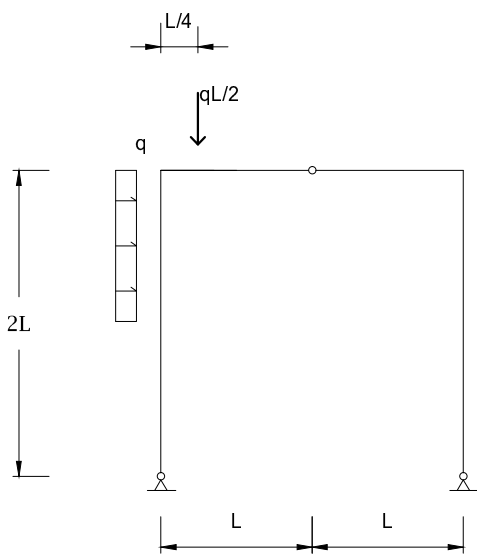

tema 45

Determinare le reazioni vincolari e diagrammi N, T, M

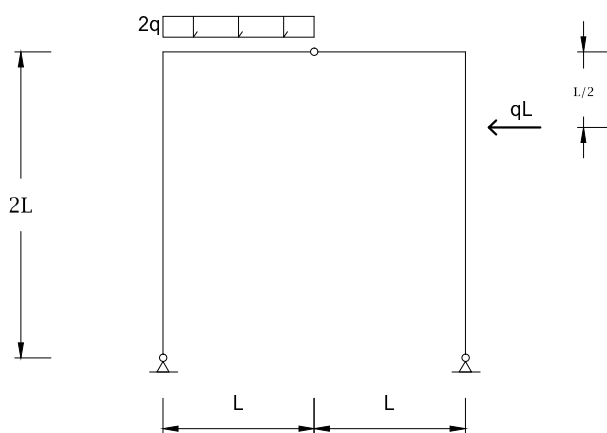

tema 46

Determinare le reazioni vincolari e diagrammi N, T, M

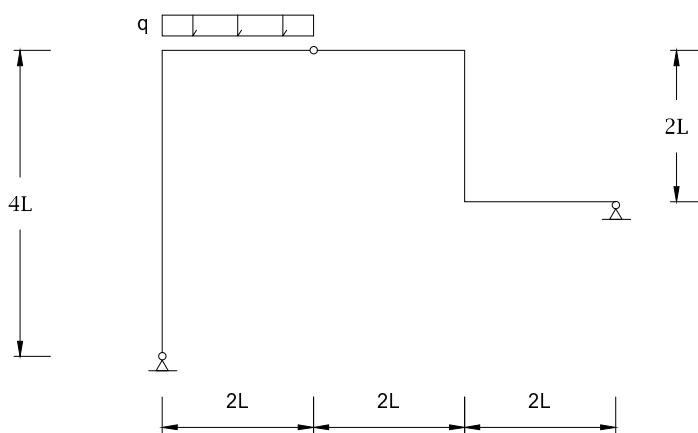

tema 47

Determinare le reazioni vincolari e diagrammi N, T, M

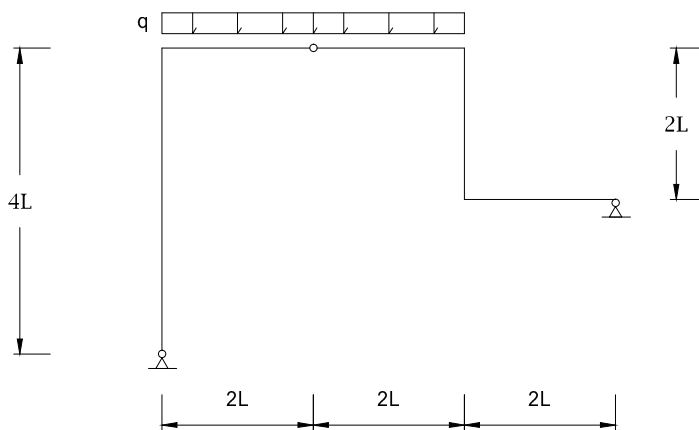

tema 48

Determinare le reazioni vincolari e diagrammi N, T, M

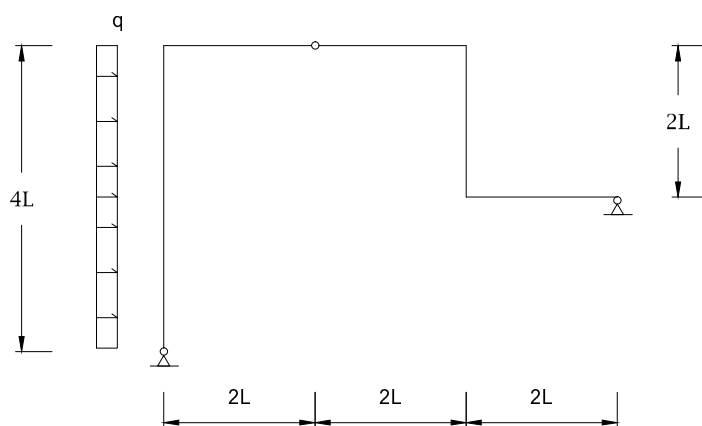

tema 49

Determinare le reazioni vincolari e diagrammi N, T, M

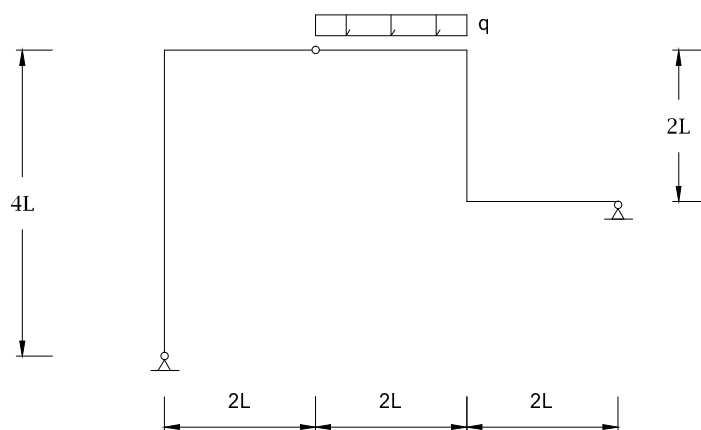

tema 50

Determinare le reazioni vincolari e diagrammi N, T, M

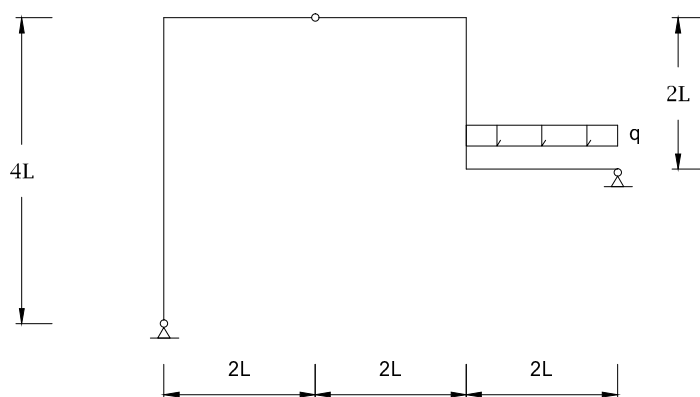

tema 51

Determinare le reazioni vincolari e diagrammi N, T, M

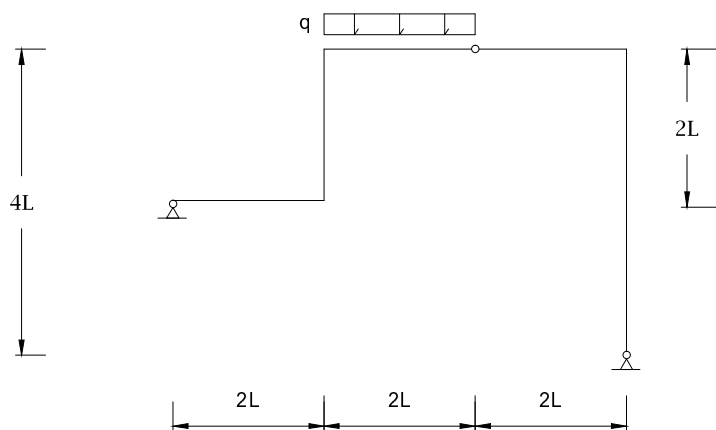

tema 52

Determinare le reazioni vincolari e diagrammi N, T, M

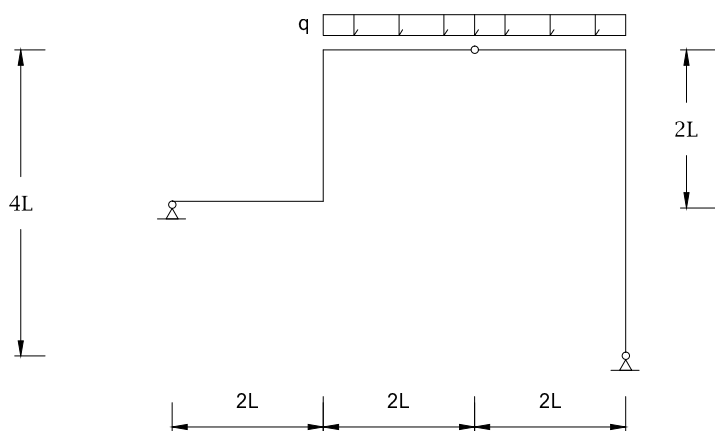

tema 53

Determinare le reazioni vincolari e diagrammi N, T, M

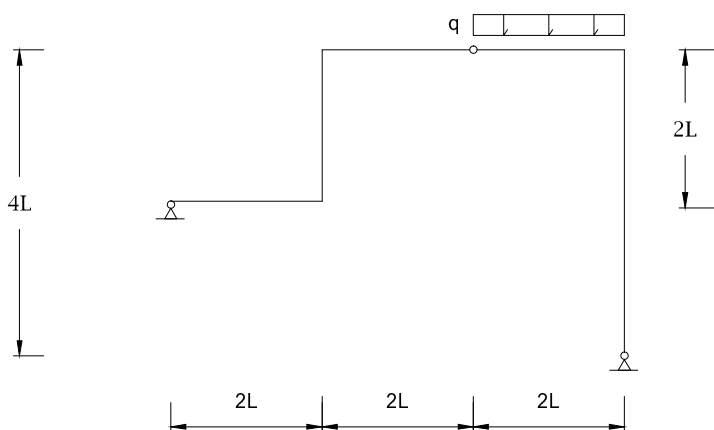

tema 54

Determinare le reazioni vincolari e diagrammi N, T, M

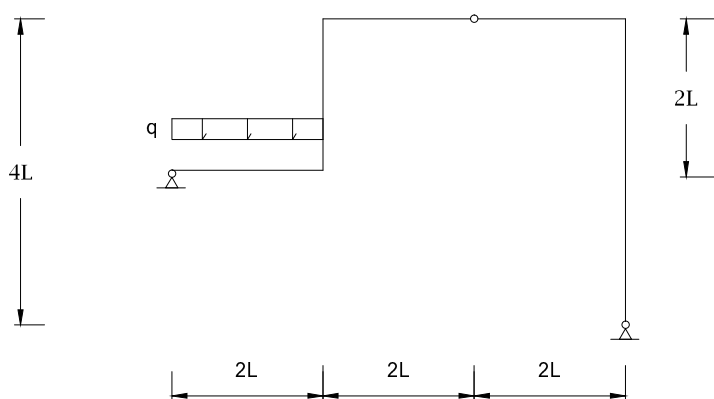

tema 55

Determinare le reazioni vincolari e diagrammi N, T, M

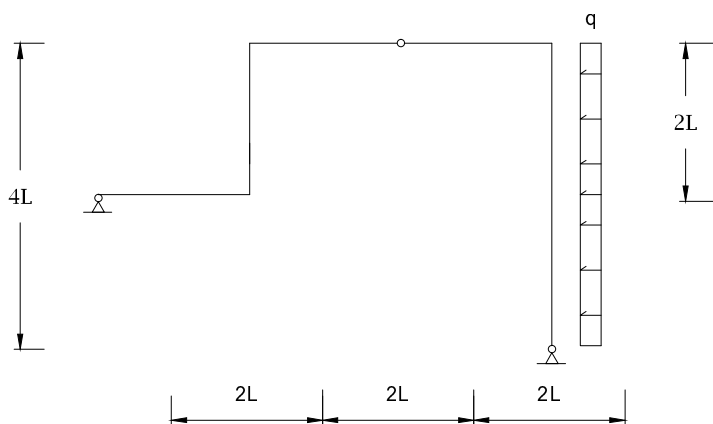

tema 56

Determinare le reazioni vincolari e diagrammi N, T, M

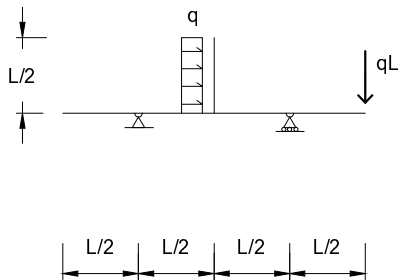

tema 57

Determinare le reazioni vincolari e diagrammi N, T, M

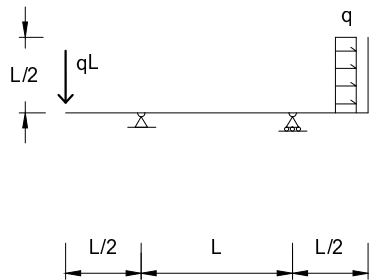

tema 58

Determinare le reazioni vincolari e diagrammi N, T, M

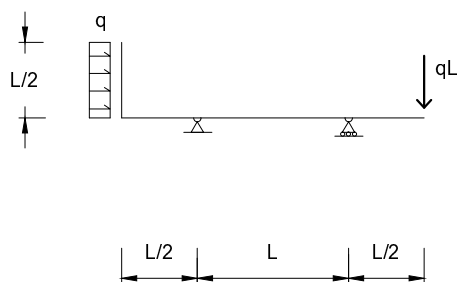

tema 59

Determinare le reazioni vincolari e diagrammi N, T, M

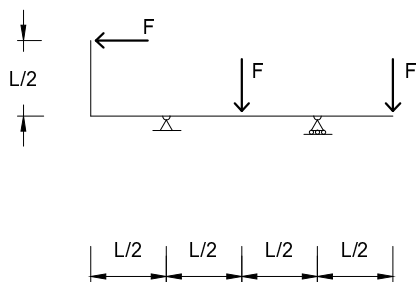

tema 60

Determinare le reazioni vincolari e diagrammi N, T, M

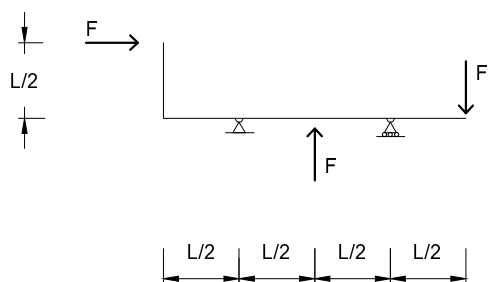

tema 61

Determinare le reazioni vincolari e diagrammi N, T, M

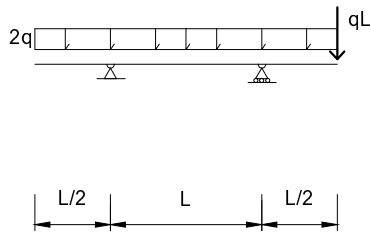

tema 62

Determinare le reazioni vincolari e diagrammi N, T, M

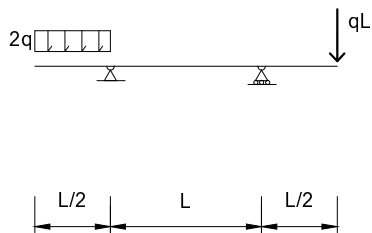

tema 63

Determinare le reazioni vincolari e diagrammi N, T, M

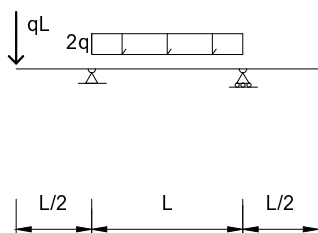

tema 64

Determinare le reazioni vincolari e diagrammi N, T, M

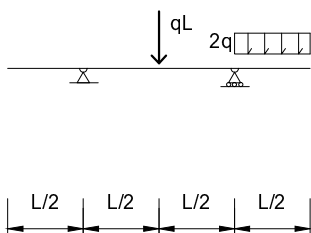

tema 65

Determinare le reazioni vincolari e diagrammi N, T, M

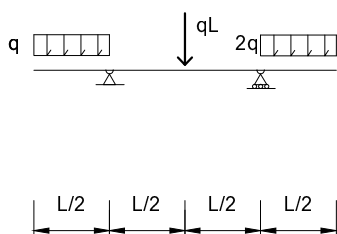

tema 66

Determinare le reazioni vincolari e diagrammi N, T, M

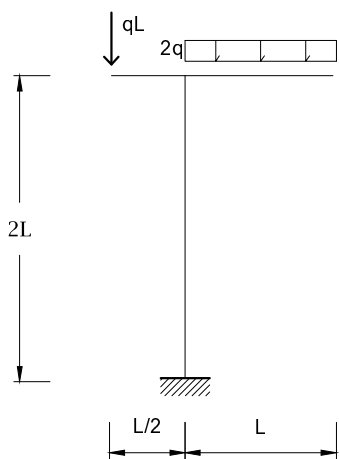

tema 67

Determinare le reazioni vincolari e diagrammi N, T, M

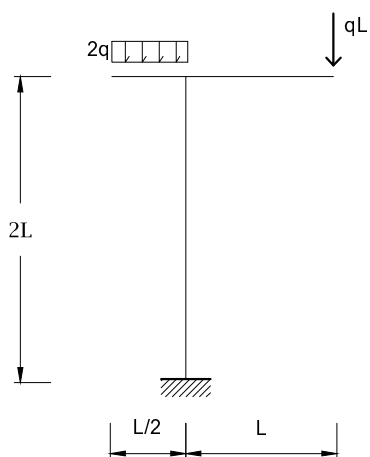

tema 68

Determinare le reazioni vincolari e diagrammi N, T, M

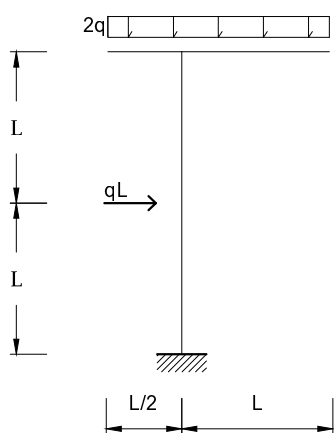

tema 69

Determinare le reazioni vincolari e diagrammi N, T, M

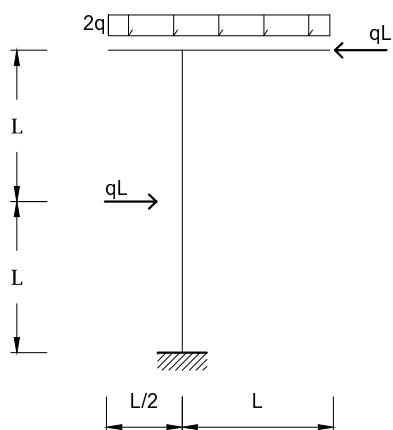

tema 70

Determinare le reazioni vincolari e diagrammi N, T, M

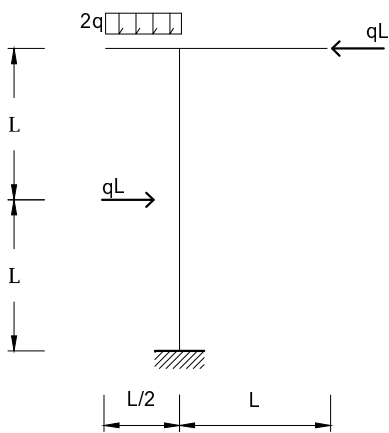

Esonero 27-10-2014
Progettazione Strutturale 1M(B) - Prof. G. Salerno

Nome:
Cognome:

Nota: L'elaborato d'esame deve essere presentato **ESCLUSIVAMENTE** su questi fogli